

GENIUS RETRACTABLE WINDOW SCREEN

EASY MEASURE & CUT SCREEN KIT INSTRUCTIONS (42MM)

- INSTALLATION QUESTIONS?
- MISSING PARTS?
- REPLACEMENT PARTS?

PLEASE CALL OUR HELPLINE

1-866-523-9511

Monday–Friday 8:00 AM to 5:00 PM CT

TOOLS:

Phillips Screwdriver
Drill and Drill Bits

Measuring Tape & Pencil
Soft Mallet
Hand-Held or Power Chop Saw

1 Mounting Options

Recess Installation: Mount the Screen Cassette using Recess Mounting Clips within the inside frame. Recess installations are the most typically used application.

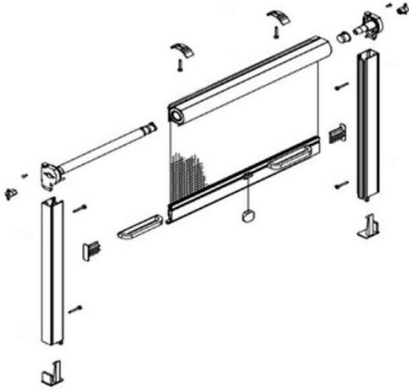

Surface Installation: Surface/Flush mounting the screen using surface mount clips on screen cassette.

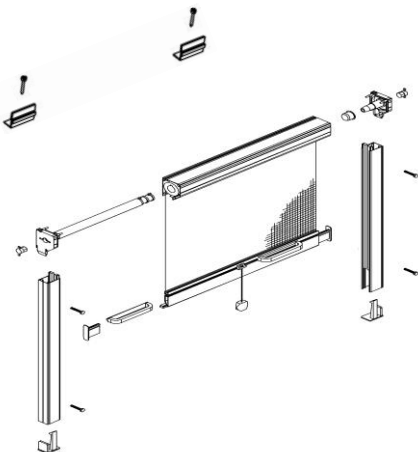

2 Measuring

Measure the opening width and height in several places and record the smallest width and height measurement.

3 Cutting the Cassette

Notice that the screen cassette has two removable stickers labeled “Begin Measuring From This End” (Side A), and another labeled “Cut This End” (Side B). Starting from Side “A”, mark your required dimension **less a 3/8” deduction** (9.5mm). The **3/8”** (9.5mm) deduction is an allowance for the cassette end cap with brake that you will install in step 5.

Firmly hold the Cassette and Pull Bar together and cut the Cassette assembly (including the screen) to size. Hold upright and tap away the metal shavings.



Cut The Entire Screen Cassette Assembly Using a Hand-Held or Power Saw With Metal Cutting Blade.

4 Cutting the Guide Rails

Mark your required net height dimension **less a 2-1/8” deduction** (54mm). Cut the side guide rails to size. Hold upright and tap away the metal shavings.

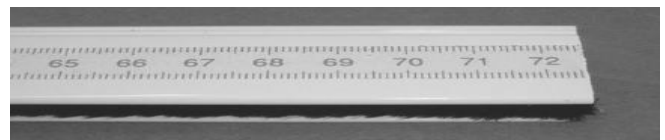

Side Guide Rail Is 1-1/8” H x 7/8” W (30mm x 22mm)

5 End Cap Assembly

If surface mounting the screen then slide one or two L-Clips into the groove on the rear of the Cassette before proceeding. The L-Clips will be used in step 8-B to secure the Cassette to the window.

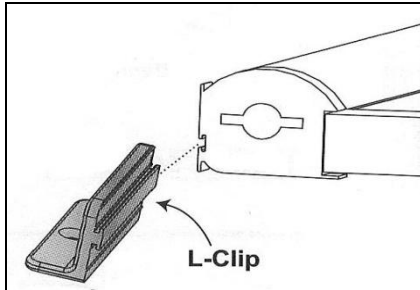

On the open end of the Cassette, insert the **END CAP with BRAKE** and then the **BUSHING** into the tube of the screen roll. Make sure that the tooth of the Bushing lines up with one of the narrow slots inside the Screen Tube. Slide the End Cap pins into the Cassette and install by tapping evenly with a soft mallet and secure the end cap with screw.

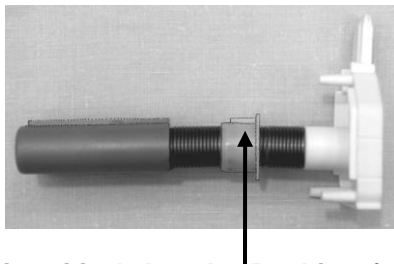

NOTE: It is critical that the Bushing (adjacent to the End Cap) is fully engaged inside the aluminum screen tube before inserting and attaching the plastic cassette end cap.



Align & Insert Brake

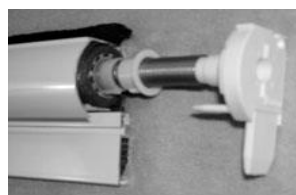

Align the Bushing with Tube



Insert the Bushing



Attach the End Cap

6 Insect Pile

Recess Mount Applications: The pile weather strip is already installed into the channel located on the rear of the Cassette.

Surface Mount Applications: Remove the pile weather stripping from the channel located on the rear of the Cassette; the pile will not be needed (see image below).



7 Pull Bar End Cap

Insert the Pull Bar End Cap into the end of the Pull Bar and tap in place using a soft mallet.



INSTALLATION

NOTE: It is critical that the Cassette and rails be installed square and plumb in the opening. If needed use shims (not supplied) to square the opening.

8 Installing the Cassette

8-A Recess Installation: Use screws to install Recess Mount Clips to the window frame approx. 4" from each side. Snap the cassette only into the mounting clips.



8-B Surface Installation: Position the cassette, insert the screws in the L-Clips and secure the screen cassette to the frame.

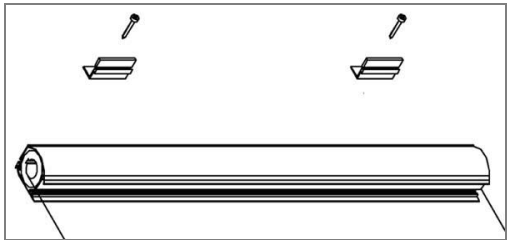

9 Install the Side Rails

9-A Recess Installation: Grasp side rails and insert the bottom internal lock/end caps. **Be certain to insert the end caps on the correct side rail so that the latch engages the pull bar as shown below.** Next, insert both side rails onto protruding tab of cassette housing end caps. Align rails plum into final position on window and fasten to frame using screws.

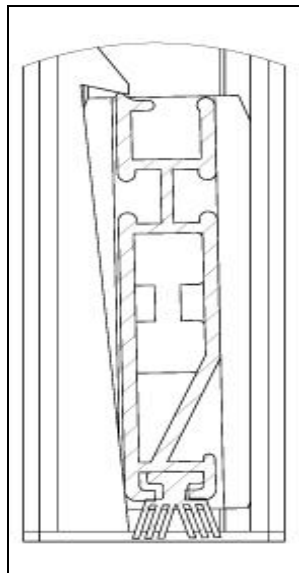
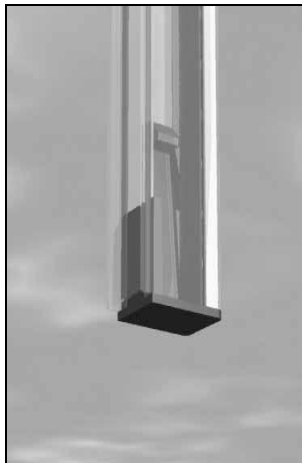

When installing the side guide rail it is helpful to use the black plastic pile opener tool that was provided with the screen kit. Insert the pile opener within the side guide rail to temporarily separate the flexible insect pile and ease the installation of the screws. Remove and discard the plastic pile opener when finished.

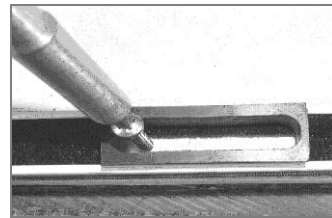

9-B Surface Installation: Using the decorative trim groove as a guide (and staying to the outside of the glide platforms inside the rail), drill 1/8" (3mm) holes evenly spaced through both sides of the guide rail. Secure the rail to the window with screws that are provided in the bag labeled "Surface Mount Kit". Do not over tighten screws.



OPERATION OF THE SCREEN:

During use the internal lock mechanism will automatically catch once the rollerscreen is fully extended. To retract the screen simply grasp the pull rail handle and provide a slight twisting action. Rotation of the pull rail is all that is needed to disengage the internal lock and retract the rollerscreen.

CAUTION:

This is not a safety or security screen. This product will not stop a child from falling, provide security or, protect your belongings. Please use eye protection when cutting and installing your screen.

GENIUS RETRACTABLE WINDOW SCREENS

EASY MEASURE & CUT SCREEN KIT INSTRUCTIONS (42MM)

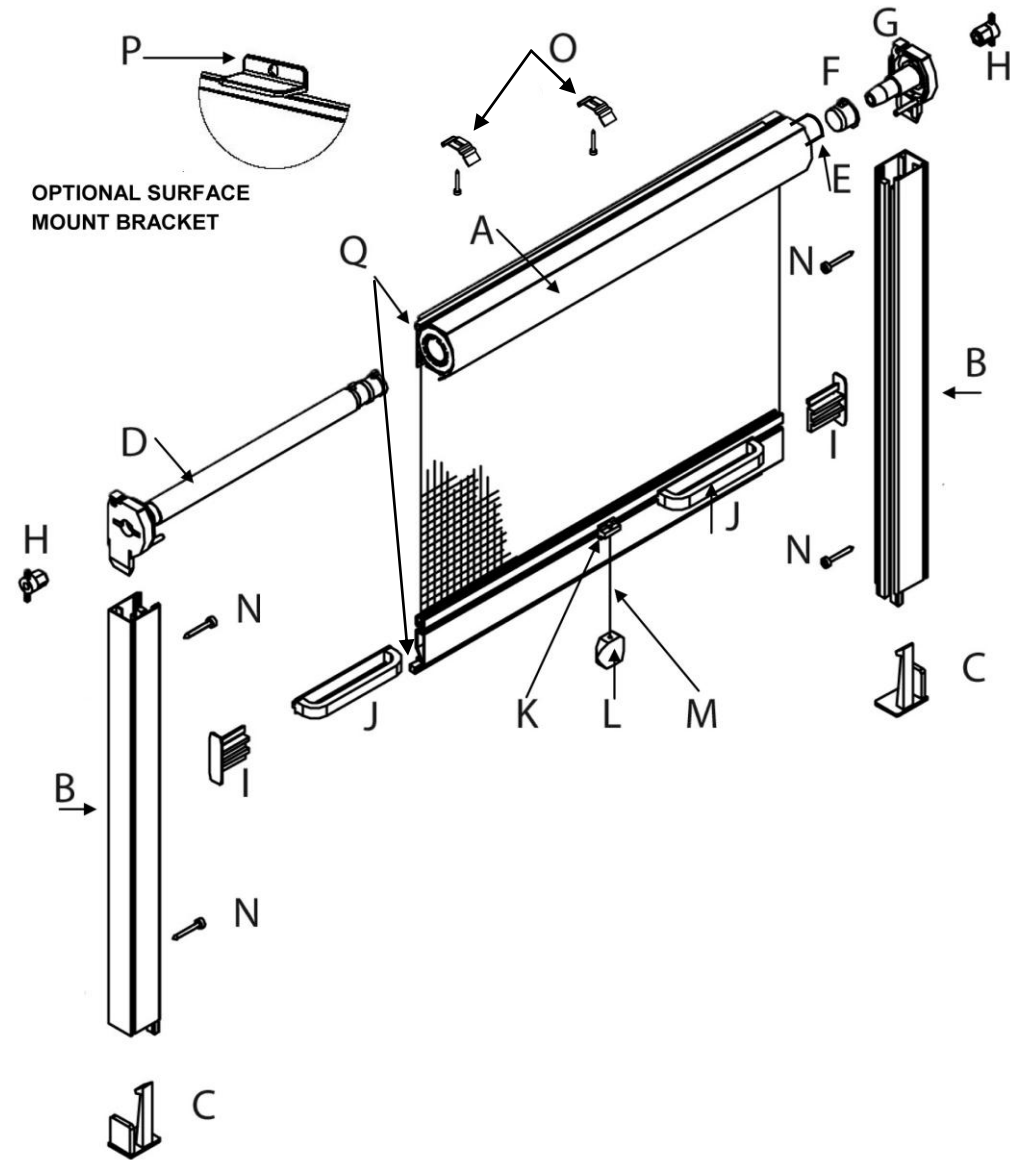

A	Screen Cassette	[Part #: 01-00743-Color]	J	Handle	[Part #: 01-13860-Color]
B	Side Guide Rail	[Part #: 01-02090-Color]	K	Cord Carrier	[Part #: 01-53920-Color]
C	End Cap/Latch	[Part #: 21-54170(L) 54160 (R)]	L	Cord Pull	[Part #: 01-53930-Color]
D	Spring Assembly	[Part #: 01-55011-Color]	M	Pull Cord	[Part #: 01-53890-0-5]
E	Brake	[Part #: 21-26010-0-0]	N	Screws	[Part #: 00-40500-0-0]
F	Bushing	[Part #: 01-13120-0-3]	O	Recess Mount Clip	[Part #: 01-13190-Color]
G	Cassette End Cap	[Part #: 01-55020-Color]	P	Surface Mount Clip	[Part #: 01-26111-Color]
H	Plug	[Part #: 01-53750-Color]	Q	Insect Pile	[Part #: 00-02010-0-5]
I	Pull Bar End Cap	[Part #: 01-53650(L) 53660(R)]	R	(Not Shown) Alternate Guide Rail Surface Mount Screws	[Part #: 00-13140-Color]

RETRACTABLE WINDOW SCREENS TROUBLESHOOTING GUIDE

<p>IT IS DIFFICULT TO PULL THE RETRACTABLE SCREEN DOWN OR THE SCREEN SEEMS TO BOUNCE AS IT OPENS AND CLOSES.</p>	<p>Check side guide rails for screws that may not have been driven flush into the guides causing the screen pull bar to rub on the screw.</p> <p>Clean any debris from inside the side guide rails.</p> <p>Make sure that the Cassette housing has a 90° cut. If not, trim so it is a straight cut.</p> <p>Check that the Bushing (item "F"), is fully inserted within the Screen Tube. A bouncing effect is a symptom that the Bushing may not be fully inserted.</p> <p>Check to see if the Pull Bar is rubbing inside the side guide rails and needs to be trimmed down.</p> <p>Check to see that the Plastic Pull Bar End Cap is gliding freely within the side guide rails and NOT within the screw chamber.</p>
<p>THE RETRACTABLE SCREEN BINDS OR WILL NOT RETRACT INTO THE CASSETTE HOUSING PROPERLY.</p>	<p>See above steps.</p> <p>Make sure that the screen fabric has a clean cut and is not jagged; if so, trim so it is a straight cut.</p> <p>Check to see if either the housing or inner tube have been twisted, bent or otherwise damaged during shipping.</p>
<p>SCREEN HAS BECOME TORN OR DAMAGED.</p>	<p>Replace the mesh using a screen refill replacement kit.</p>

VIEW THE ON-LINE
EASY INSTALLATION VIDEO AT
WWW.GENIUSSCREENS.COM

- INSTALLATION QUESTIONS?
- MISSING PARTS?
- REPLACEMENT PARTS?

CALL OUR HELP LINE AT
1-866-523-9511
MONDAY-FRIDAY 8:00 AM TO 5:00 PM CT