

INSTALLATION INSTRUCTIONS  
**PETITE CASEMENT VERTICAL WINDOW SCREEN**  
(FOR OPENINGS UP TO A MAXIMUM OF 36" IN WIDTH)

Measuring and installation of your new window rollerscreen is quick and simple. A typical installation involves mounting the screen housing in the recesses of the window. Recess mounting clips are typically NOT used for this application. The screen housing will rest within the natural profile of the window frame where it remains virtually unnoticed.

Begin by identifying the location where the housing will rest. Start by measuring the tight dimensions of the opening area where the rollerscreen will rest; record your measurements.

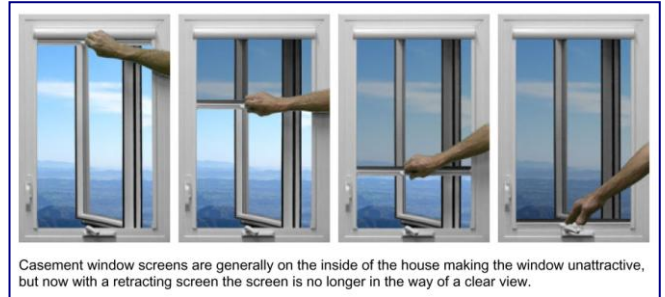

**Dimensions:**

Housing: \_\_\_\_\_ [Deduct 11/16" Before Cutting]

Side Rails: \_\_\_\_\_ [Deduct 1-5/8" Before Cutting]

**Procedure:**

Once you have determined the location for the screen cassette housing and the sizes needed, place the length of housing on your table and carefully unwrap. Mark the exact dimension of your cut remembering first to **subtract 11/16"** from the housing measurement of the opening to account for the housing ends caps that you will apply in subsequent steps. Cut the cassette to size and then tap away any metal shavings.

To help assure that the screen operates smoothly it is recommended that you now trim the petite pull bar an added 1/8"-3/16". Doing so will provide added room for the screen to operate and this is helpful if the window has any bow or is now absolutely plumb, square and level. Before installing the pull bar end cap make a slight 45° notch (Fig. A), on both the left and right side of the rubberized bonding strip so that once installed the end caps will rest flush with the edge of the screen (Fig. B)

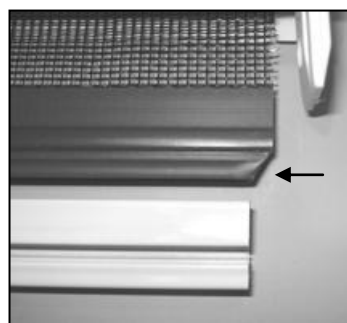

Fig. A

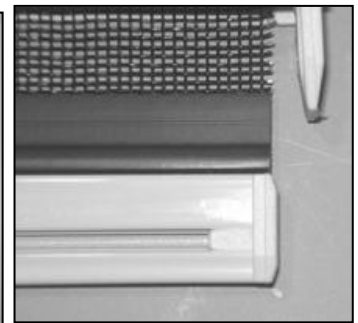

Fig. B

Now, place the housing on the table, open the accessory kit and empty contents for assembly. Insert the spring assembly in the proper end. The spring will require the proper amount of tension (see tension chart), using a clockwise winding motion (Fig. C). You may wish to adjust these numbers to

Housing Length	Spring Tension
24"	6-8 Turns
30"	10-12 Turns
36"	12-14 Turns

Fig. C

match personal preferences. Out of square openings, debris and other factors can affect the drag upon the screen. Also, tension may be adjusted to help compensate for areas with higher winds; winds strong enough to blow the mesh and create a slight sail effect. The more spring tension (or turns), the tighter the screens resistance and rigidity while the screen is engaged (extended). Adjust the speed of the screens retraction by slight adjustments to the spring tension. Insert and the bushing inside the screen roll tube, tap the end cap fully onto the screen cassette and secure the end cap with screw.

Now, turn your attention to the other end of the housing. Insert the opposite cassette end cap (Fig. D), making sure to insert the bushing fully inside the screen roll tube. Push the end cap pins into their openings and tap evenly with a soft mallet until the end cap is flush with the end of the housing. Insert the screw to secure the cap. When installing the end caps take care to the screw does not miss the screw chamber and damage the screen fabric.



Fig. D

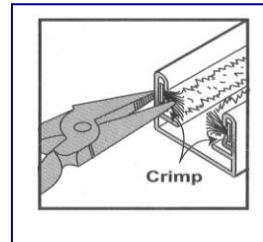

Fig. E

Install handles within the grooves of the pull rail, the optional pull cord assembly, the bug pile in the end groove of the pull rail and finally the pull rail end caps. Measure the side guide rails to length making certain to apply the correct deduction from the net opening size before cutting the guide rails. Crimp the very ends of each side guide rail extrusion with pliers. Crimping these ends is critical to prevent the insect piling from sliding out of the rails (Fig. E).

### **Installation:**

**1** –Set the screen cassette in place (Fig. F).

**2** – Grasp side rails and insert the bottom internal lock end caps (Fig. G). Make certain that the catch of the end cap/latch is positioned to connect with the pull bar as shown (Fig. H). Insert both side rails onto protruding edge of screen cassette end caps (Fig. I). Align rails plum into final position on window and fasten to window frame using screws (Fig. J).



Fig. F

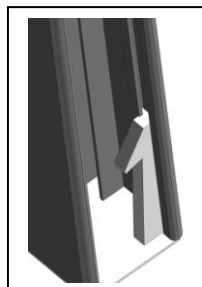

Fig. G

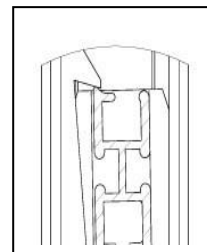

Fig. H



Fig. I



Fig. J

### Operation:

During use the internal lock mechanism will automatically catch once the screen is fully extended. To retract the screen simply grasp the pull rail handle and provide a slight twisting action. Rotation of the pull rail is all that is needed to disengage the internal lock and retract the rollerscreen.

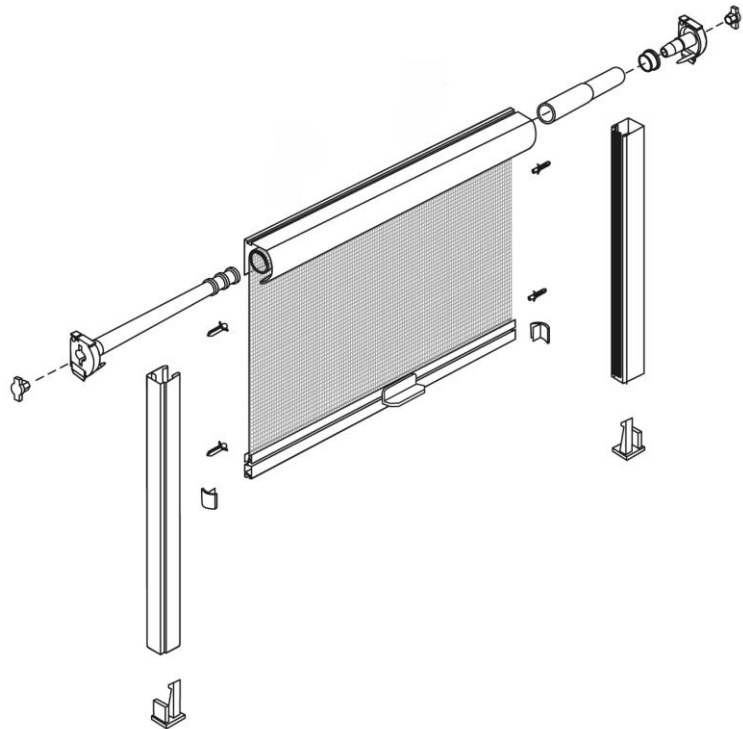

**Spring:** The standard spring mechanism supplied by Genius is approximately 18-5/8" long. To allow for the opposite end cap with brake and, spring expansion, please be advised that you will need to use a shorter than normal spring for windows which are narrower than 25". Shorter springs are available from Genius or you may simply trim-down the traditional spring which has been supplied. Please be certain to allow at least 1-1/4" gap between the spring mechanism and the brake in order to allow for spring expansion.

### **Tools:**

- A manual saw with metal blade or a power saw with a 10" or larger 70 (or more), tooth carbide tip blade suitable for cutting non-ferrous metals.
- Drill with appropriate Phillips tips (reversible tip with drill bit and tip combo is helpful)
- Drill bits – Soft Hammer – Tape Measure