



MILANO 100

SINGLE DOOR SCREEN

OWNER'S GUIDE AND INSTALLATION

MILANO 100 RETRACTABLE SCREEN DOOR

Thank you for choosing the GENIUS[®] MILANO retractable screen door. These instructions are split into three sections: CUSTOM SIZING (page 6), INSIDE THE FRAME INSTALLATION (page 9), and OUTSIDE THE FRAME INSTALLATION (page 14). Determine which you need before starting. If you have purchased a custom made screen please bypass the custom sizing section and proceed directly to the installation section. These instructions demonstrate installation methods for single panel hinged entry doors. For help installing on a sliding patio or other door please contact us or visit www.geniusscreens.com.

Please read the complete installation instructions before proceeding with installation.

INSTALLATION TOOLS



**Power Screw Driver
with Phillips Bit
& Drill Bits**

Hacksaw

Tape Measure

Installation Questions?
Replacement Parts?

WE CAN ASSIST YOU.
1-866-523-9511

Watch the installation video at
www.geniusscreens.com/videos/
or scan this QR Code



MEASURING GUIDE

MEASURING A TYPICAL HINGED DOOR FOR THE NET SCREEN OPENING DIMENSIONS

Determine the "NET SCREEN OPENING DIMENSION" (width x height) as measured from where the outside most edges of the retractable screen will rest. Screens are then made to fit these dimensions.

INSTALLATION TYPE

- OPTION A** Inside the Frame
- OPTION B** Fully Inside the Frame
- OPTION C** Outside the Frame

RECORD MEASUREMENTS

W _____

H _____

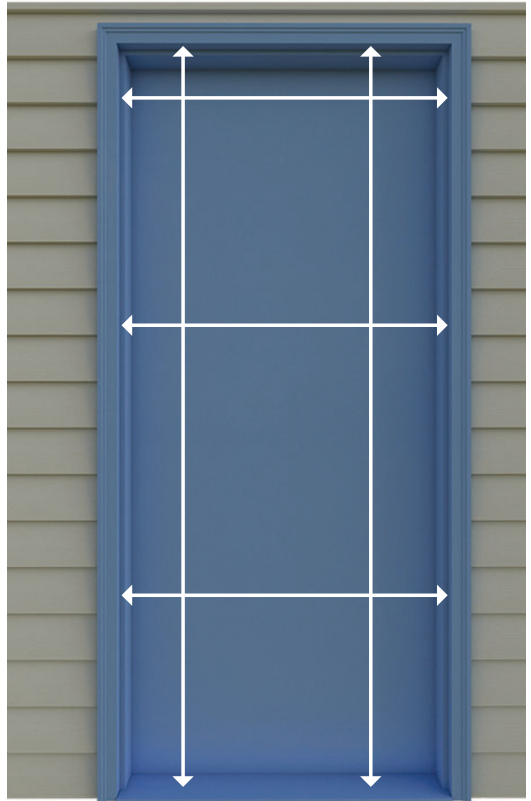

OPTION A (Recommended)
INSIDE THE FRAME INSTALLATION
(Recess Mounted) at the Brick Mold

MOST COMMON!

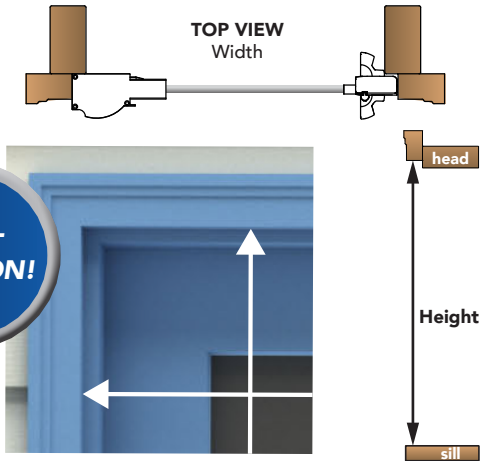

OPTION B
INSIDE THE FRAME INSTALLATION
Fully Inside the Frame

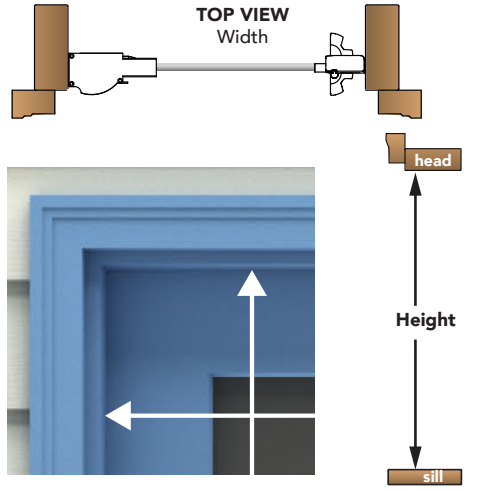

OPTION C
OUTSIDE THE FRAME INSTALLATION
(Surface Mounted)

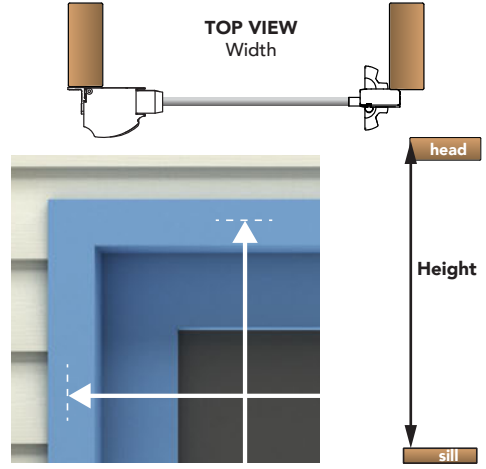

INSIDE THE FRAME INSTALLATION

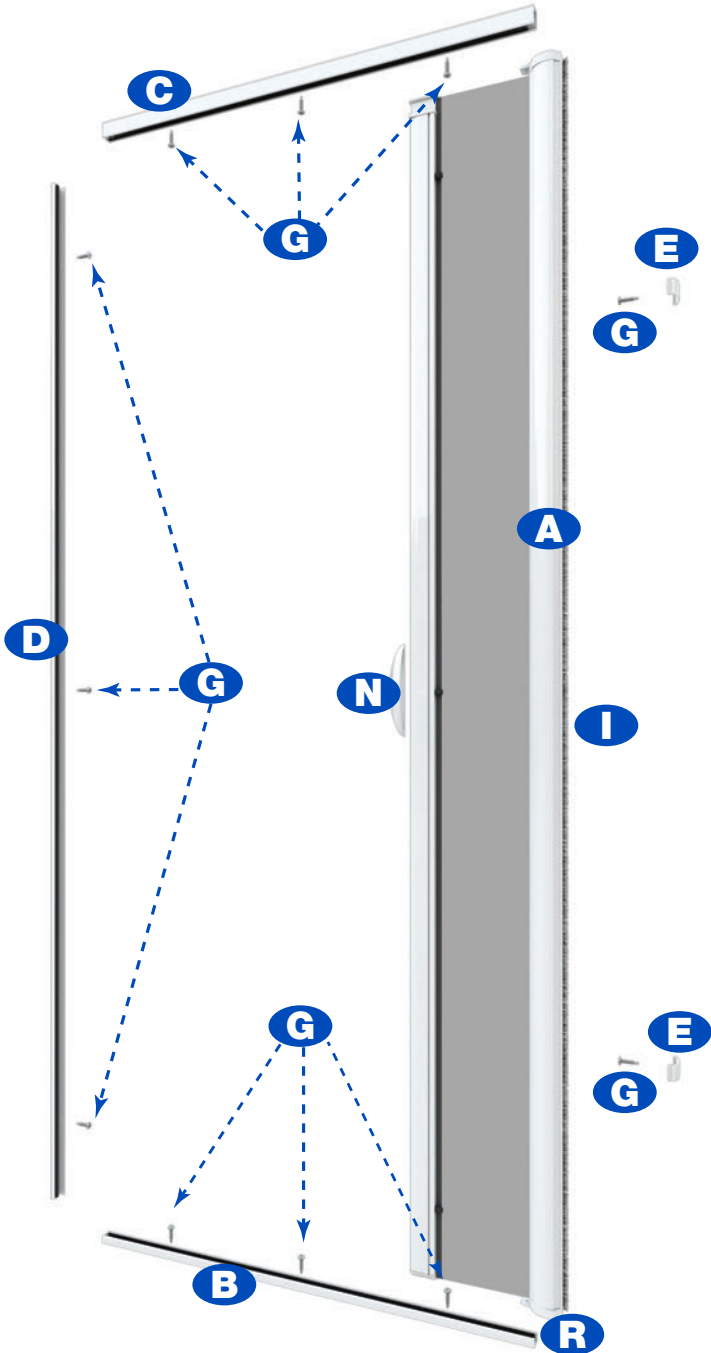

PART DESIGNATIONS

- | | |
|--|---|
| A Screen Cassette Assembly | I Insect Pile Weatherstrip |
| B Bottom Guide Rail | J Sloped Threshold Shims |
| C Top Guide Rail | K Allen Wrench |
| D Side Rail with Magnet | L Pile Opener |
| E Inside Mount Clips | M #6 x 3/4" Cassette End Cap Screw |
| F Outside Mount Clips | N Handle |
| G #8 x 3/4" (19mm) Phillips Panhead Screws | R Cassette End Cap |
| H #6 x 1-3/4" Phillips Outside Mount Screws | |

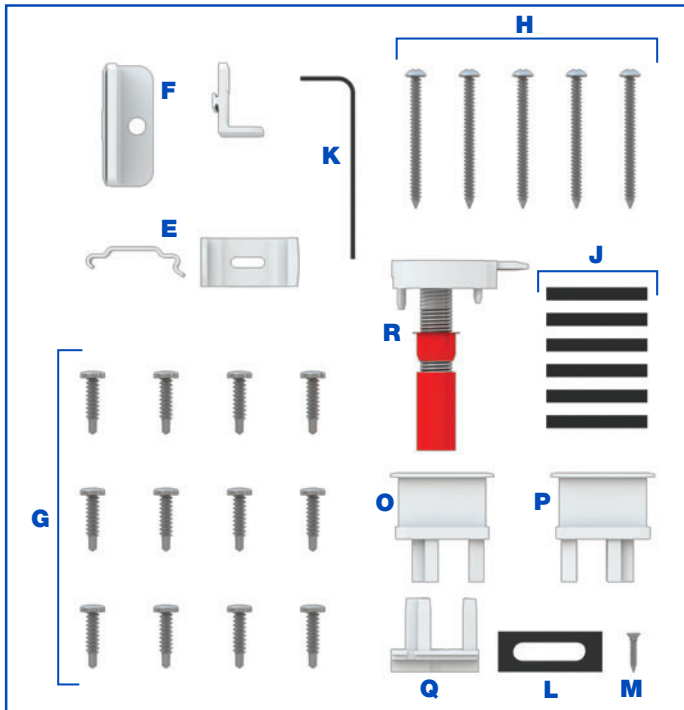

PARTS KIT

- | | |
|--|--|
| E Inside Mount Clips | M #6 x 3/4" Screw for Cassette End Cap |
| F Outside Mount Clips | O Top Pull Bar End Cap for Left-Hand Installations |
| G #8 x 3/4" (19mm) Phillips Panhead Screws | P Top Pull Bar End Cap for Right-Hand Installations
(already installed when ordering a custom made screen) |
| H #6 x 1-3/4" Phillips Outside Mount Screws | Q Bottom Pull Bar End Cap for Left-Hand Installations |
| J Sloped Threshold Shims | R Cassette End Cap with Bushing and Brake |
| K Allen Wrench | |
| L Pile Opener | |

CUSTOM SIZING

If you have purchased a custom made screen than bypass this custom sizing section and proceed directly to the installation section. Installation can be made inside the frame (pages 9–13) or outside the frame (pages 14–18). Determine the type of installation that you will do, measure the opening and proceed as instructed.

1 CUTTING THE CASSETTE

To custom size the already partially assembled A-Screen Cassette Assembly, take the height of the net screen opening and subtract $3/8"$ (9.5mm). This will become your overall cut dimension. This deduction provides an allowance for the R-Cassette End Cap that you will install in STEP 4. Now measuring from the outside of the one already installed R-Cassette End Cap mark the place where you will cut the A-Screen Cassette Assembly.

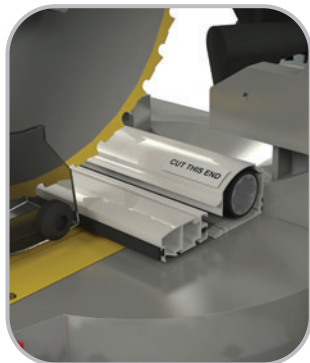

1.1

Firmly hold the A-Screen Cassette Assembly (with Pull Bar) and cut to size (including the screen fabric) [FIG 1.1]. Hold upright and tap away the metal shavings. Now only the aluminum Pull Bar of the A-Screen Cassette Assembly needs to be trimmed down a little more. Slide the aluminum Pull Bar a few inches away from the screen fabric and magnetic strip, measure and then cut so that just the aluminum Pull Bar (without the plastic end caps) is a total of $2-3/16"$ (56mm) shorter than the height of the net screen opening that you measured and recorded earlier (FIG 1.2).

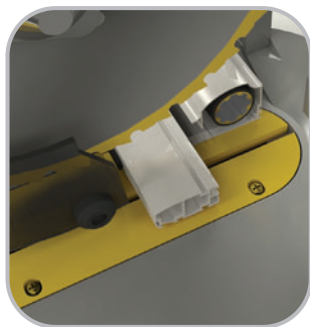

1.2

2 CUTTING THE TOP, BOTTOM AND SIDE GUIDE RAIL WITH MAGNETIC PROFILES

Using the **original Net Screen Opening Dimension** from page 2 as the starting point cut these profiles to the following lengths:



2.1

	NET OPENING DIMENSION		
B-Bottom Guide Rail	____(W)	- $2-5/16"$ (59mm)	= ____
C-Top Guide Rail	____(W)	- $2-5/16"$ (59mm)	= ____
D-Side Rail with Magnet	____(H)	- $3/32"$ (2.5mm)	= ____

After cutting the B-Bottom Guide Rail and C-Top Guide Rail, use pliers to crimp the Pile/Weather Strip in place [FIG 2.2] so that it does not move in the holding channels.

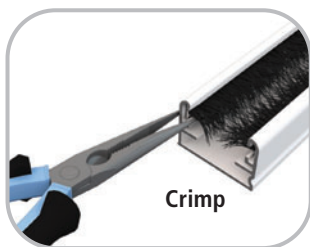

2.2

3 INSECT PILE WEATHERSTRIP

Recess Mount Applications (inside the frame) : The I-Insect Pile/Weather Strip is already installed in the channel located on the rear of the Cassette.

Surface Mount Applications (outside the frame) : Remove the I-Insect Pile/Weatherstrip from the channel at the top back of the A-Screen Cassette [FIG 3.1]. Then slide the runners on the bottom of the F-Outside Mount Clips into the same channel [FIG 3.2]. Note: the position of the L-Surface Mount Clips can be adjusted at any time once installed in the channel.



3.1

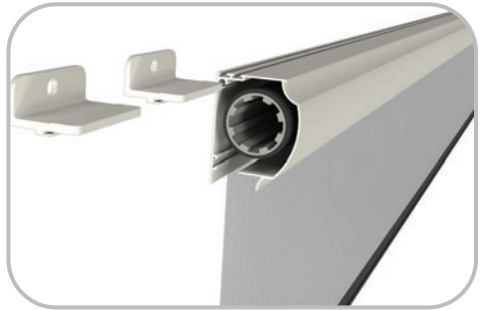

3.2

4 END CAP ASSEMBLY

W-Brake, T-Bushing and R-Cassette End Cap come pre-assembled.

Slip the T-Bushing down the coiled spring to the W-Brake. On the open end of the A-Screen Cassette, insert the W-Brake with T-Bushing into the center of the Screen Tube, aligning the long tooth on both. Next, match up the large pin on the top of the R-End Cap to the corresponding hole at the top of the A-Screen Cassette Housing. Tap evenly with a soft mallet until the assembly fits snugly, and secure with #6x3/4" screw [FIG 4.1].

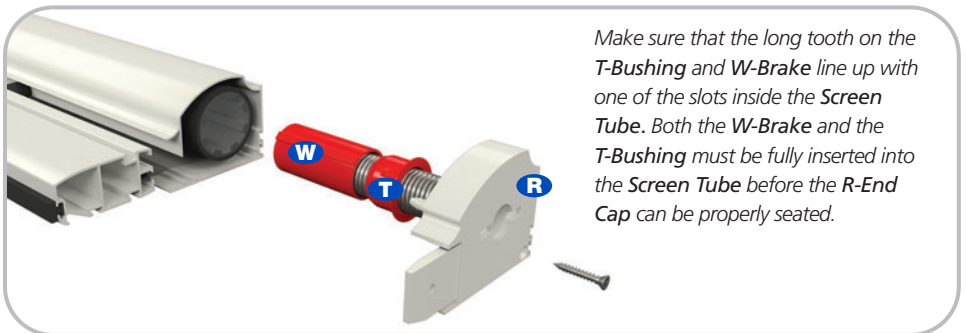

Make sure that the long tooth on the T-Bushing and W-Brake line up with one of the slots inside the Screen Tube. Both the W-Brake and the T-Bushing must be fully inserted into the Screen Tube before the R-End Cap can be properly seated.

4.1

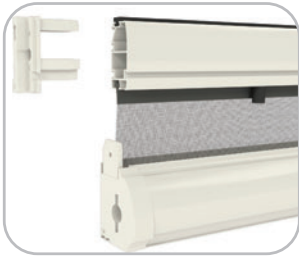

5.1

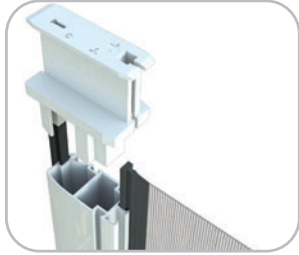

5.2

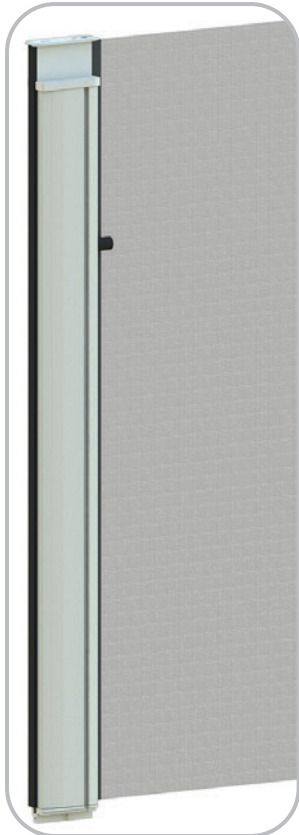

5.3

5 PULL BAR END CAPS

The A-Screen Cassette Assembly can be installed on either side of the door. The side that you select will determine if you install the right or left handed version of the **Bottom and Top Pull Bar End Caps [O, P, Q]**.

Since the Pull Bar End Caps are handed parts the side of the door where you choose to install the screen will determine if you use the right or left handed version of the Bottom and Top Pull Bar End Caps. **Always install the TALLER PULL BAR END CAP [FIG 5.2], so it rest at what will be the top of the screen and the SHORTER PULL BAR END CAP at the bottom [FIG 5.1].** Each Pull Bar End Cap will have either the letter "R" or "L" to indicate if it is for a right or left handed screen. Notice that the Top Pull Bar End Cap has 2 long channels, one where the screen fabric inserts and another to hold the magnet. Insert the appropriate top and bottom Pull Bar End Caps and tap in place using a soft mallet.

INSIDE THE FRAME MOUNTING LOCATION

The A-Screen Cassette will be mounted within the door frame using E-Inside Mounting Clips. You will want to install the screen cassette on the same side as the door hinges.

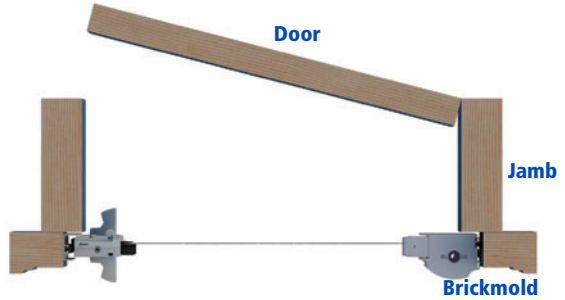

You may choose to position the screen inside the door frame in one of the locations shown below. Typically the handle on the door does not affect the screen placement decision. This is because the door will be open while the screen is being used and the screen will be retracted when the door is closed.

Measure the opening width and height in several places and record the smallest width and height measurements.

INSTALLATION TYPE

- OPTION A** Inside the Frame
 OPTION B Fully Inside the Frame

RECORD MEASUREMENTS

W _____
 H _____

OPTION A (Recommended)

INSIDE THE FRAME INSTALLATION
 (Recess Mounted) at the Brick Mold

OPTION B

INSIDE THE FRAME INSTALLATION
 Fully Inside the Frame

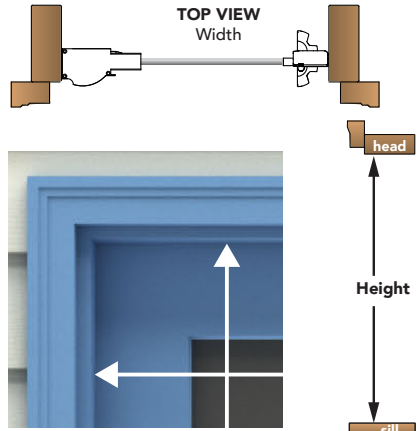
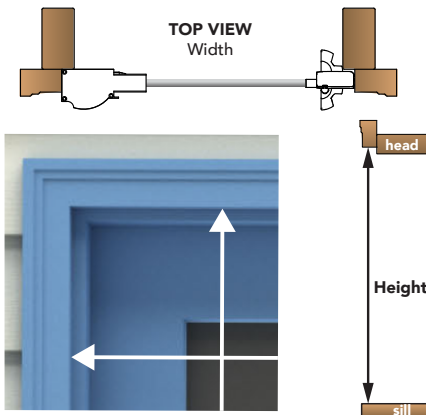

1 THE SCREEN CASSETTE

The A-Screen Cassette Assembly can be installed on either the right or left side of the door jamb. The Screen Cassette comes from the factory for right-handed installation. For a left-handed install, flip the Screen Cassette vertically, remove and discard the right-oriented P-Pull Bar End Caps and replace with the left-oriented Pull Bar End Caps [O,Q] from the Screen Accessory Kit. Remember, for either orientation, **the TALLER Pull Bar End Cap must always be at the top** [FIG 1.1].

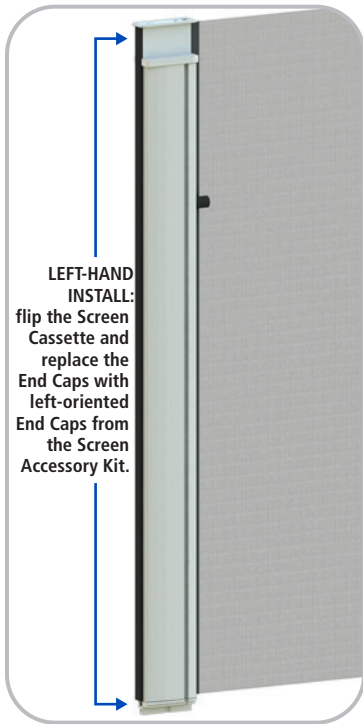

1.1

2 INSTALL THE CASSETTE

Measure over 3/4" and install the Recess Mounting Clips 20" from the top and bottom of the door opening using the #8 x 3/4" (19mm) Phillips Panhead Screws [FIG 2.1]. Snap the Screen Cassette onto the mounting clips [FIG 2.2].

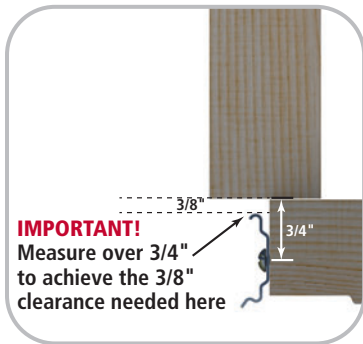

2.1

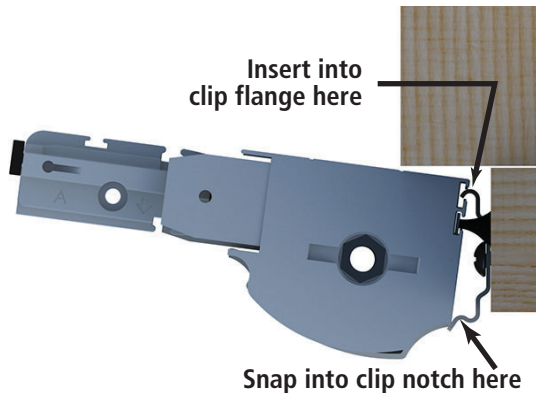

2.2

3 INSTALLING THE TOP AND BOTTOM GUIDE RAILS

Slide the **B-Bottom Guide Rail** fully onto the tab on the **A-Screen Cassette End Cap** [FIG 3.1]. Repeat for the **C-Top Guide Rail** [FIG 3.2]. Position the **C-Top Guide Rail** onto the tab of the **A-Screen Cassette** [FIG 3.3].

NOTE: The front of the top and bottom guide rail has an indented groove that should face the outside.



3.1



3.2



3.3

4 INSTALL SIDE RAIL

Slide the **D-Side Rail** behind and over the **A-Top Guide Rail** and **B-Bottom Guide Rail**, so that the **Top Guide Rail** and **Bottom Guide Rail** are positioned inside the flanges of the **D-Side Rail** [FIG 4.1, 4.2].

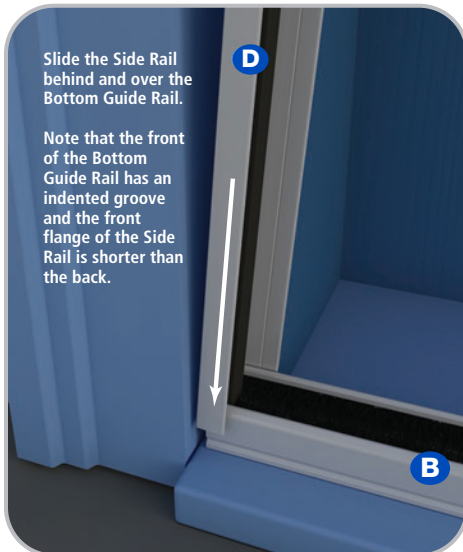

4.1



4.2

5 DOOR THRESHOLDS / SILLS

There are many different door threshold/sill designs. Be aware of the threshold type and know that it is important to have or create a level and stable surface when installing the **Bottom Guide Rail**. The following are two of the more common threshold/sill designs and ways to install the **Bottom Guide Rail**.



Flat Threshold
Porte Plats

FLAT THRESHOLD / SILL

Clean the surface and then mount the **B- Retractable Screen Bottom Guide** directly to the threshold/sill.



Sloped Threshold

SLOPED THRESHOLD / SILL

Make a flat and stable surface by installing **J-Shims** under the **B-Bottom Guide Rail**.

OPTIONAL THRESHOLD TRANSITION

Before securing the **B-Bottom Guide Rail**, you may choose to install a **Threshold Transition** with **End Caps**. This optional feature is ordered separately and helps protect the **B-Bottom Guide Rail** and it is also a nice aesthetic feature. The **Threshold Transition** may be installed toward the interior or exterior of the home or use two for this feature on both sides of the **B-Bottom Guide Rail**.

To install, cut the **Threshold Transition** to the door opening width, less 4-1/4" (114mm). Insert the **Threshold Transition End Caps**, and slide the lip of the **Threshold Transition** under the **Bottom Guide Rail**.

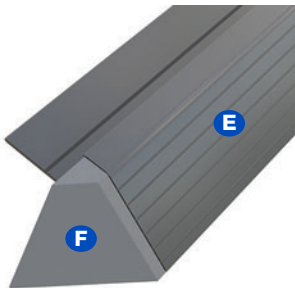

Profiles of Bottom Guide Rail and Threshold Transition

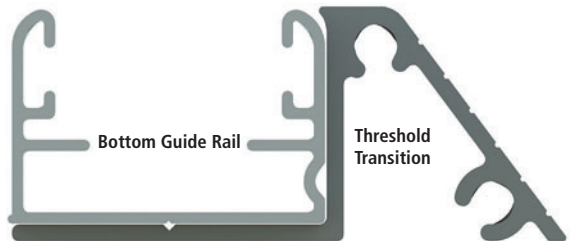

6 SECURE THE RAILS WITH SCREWS

Secure the **B-Bottom Guide Rail**, **C-Top Guide Rail** and **D-Side Rail** with Magnet with three **I-#8 x 3/4" (19mm) Phillips Panhead Screws** each [FIG 6.1]. Position screws six inches (150mm) in from each end and center the middle one.

When installing the **Bottom** and **Top Guide Rail**, use the convenient **L-Pile Opener** included with this kit, to temporarily separate the two insect piles. This will make for easier viewing and installation of the screws [FIG 6.2].



6.2

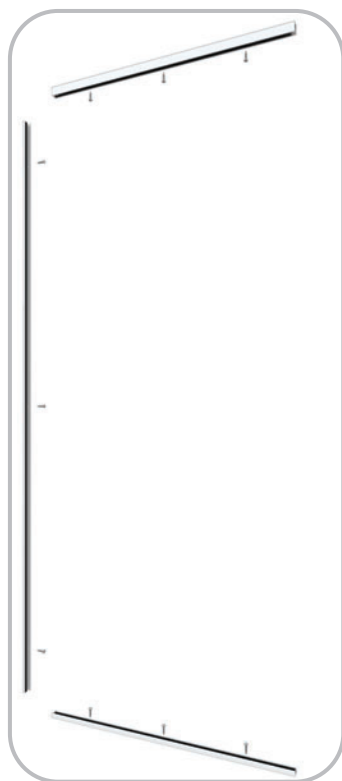

6.1

7 ADJUST THE HANDLES

Adjust the **N-Handle** heights by loosening the **Allen-Head Set Screw**, move the **Handle** as desired and retighten screw [FIG 7.1]. For your convenience, the **K-Allen Wrench** is located in the accessory kit for this step.



7.1

That's it. Enjoy your new Genius Retractable Screen!

For more great retractable screen ideas for your home, please visit
www.geniusscreens.com

OUTSIDE THE FRAME INSTALLATION

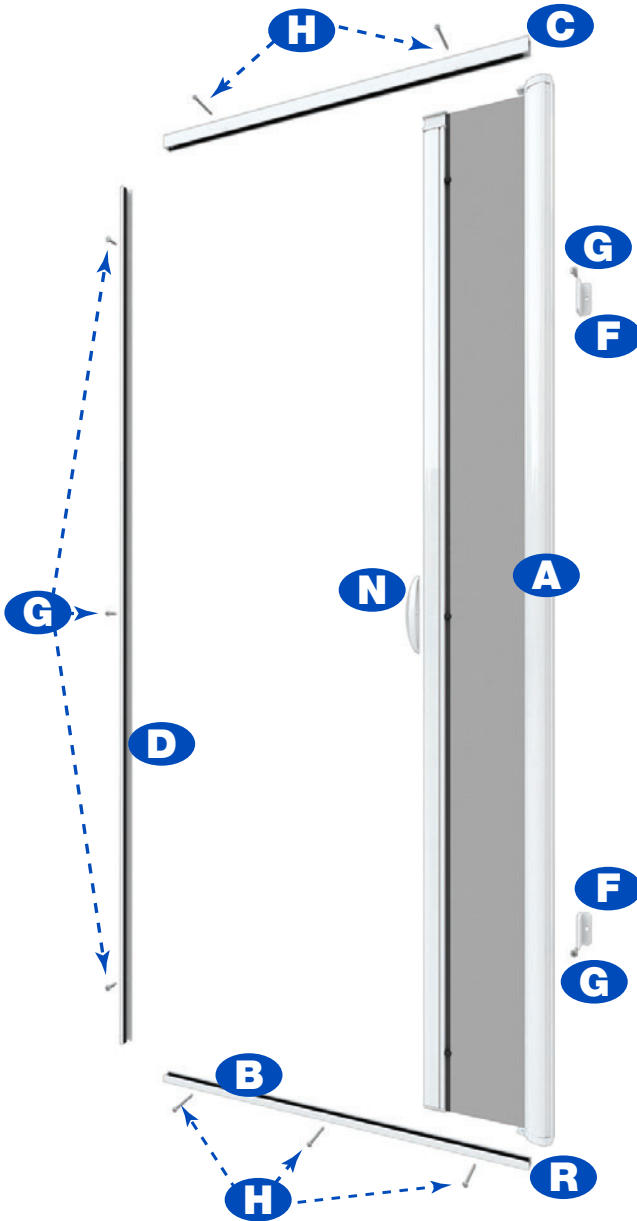

PART DESIGNATIONS

- A** Screen Cassette Assembly
- B** Bottom Guide Rail
- C** Top Guide Rail
- D** Side Rail with Magnet
- E** Inside Mount Clips
- F** Outside Mount Clips
- G** #8 x 3/4" (19mm) Phillips Panhead Screws
- H** #6 x 1-3/4" Phillips Outside Mount Screws
- I** Insect Pile Weatherstrip
- J** Sloped Threshold Shims
- K** Allen Wrench
- L** Pile Opener
- M** #6 x 3/4" Cassette End Cap Screw
- N** Handle
- R** Cassette End Cap

1 POSITIONING

For an outside the frame installation (surface mounted), mount the **A-Screen Cassette** using the **F-Outside Mount Clips** and G-#8 x 3/4" (19mm) Phillips Panhead Screws (see step 4).

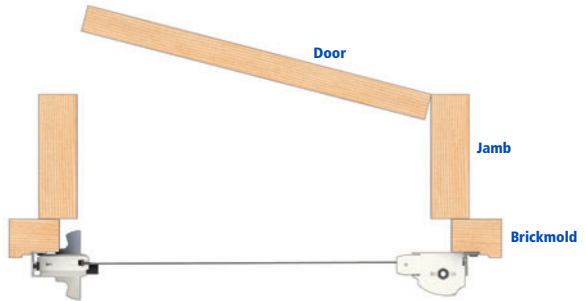
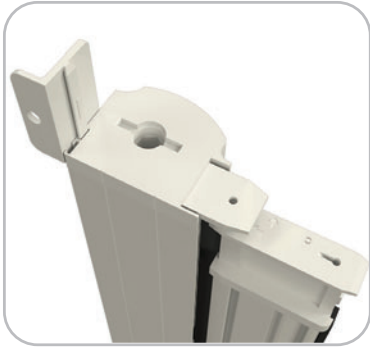

2 MEASURE THE OPENING

Measure the opening width and height in several places and record the smallest width and height measurement.

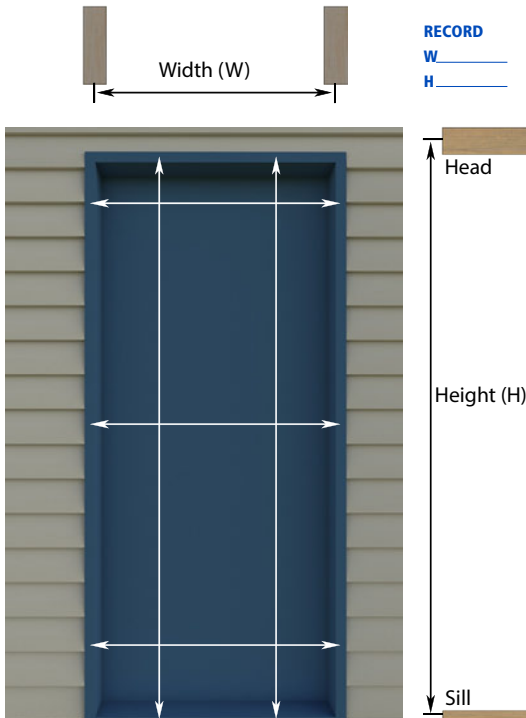

3 THE SCREEN CASSETTE

The A-Screen Cassette Assembly can be installed on either the right or left side of the door jamb. The Screen Cassette comes from the factory for right-handed installation. For a left-handed install, flip the Screen Cassette vertically, remove and discard the right-oriented Pull Bar End Caps and replace with the left-oriented Pull Bar End Caps [O,P,Q] from the Screen Accessory Kit. Remember, for either orientation, **the TALLER Pull Bar End Cap must always be at the top** [FIG 3.1].

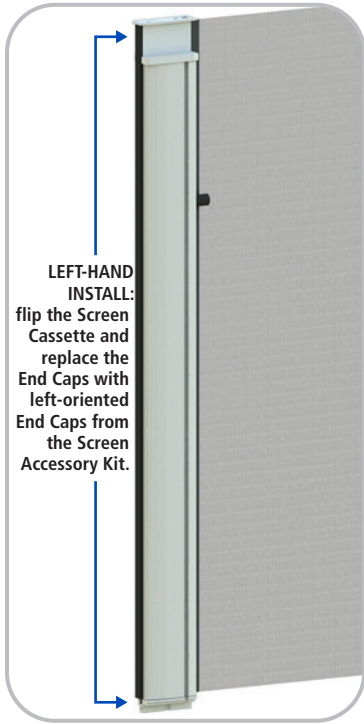

3.1

4 INSTALL THE CASSETTE

Remove and discard the I-Weather Strip from the back of A-Screen Cassette. Slide two F-Outside Mount Clips into the groove on the rear of the Screen Cassette before proceeding [FIG 4.1, 4.2]. Position the A-Screen Cassette, and use one #8 x 3/4" (19mm) Phillips Panhead Screw to secure Outside Mount Clips to the opening [FIG 4.3].



4.1



4.2



4.3

5 INSTALLING THE TOP AND BOTTOM GUIDE RAILS

Slide the **B-Bottom Guide Rail** fully onto the tab on the **A-Screen Cassette End Cap** [FIG 5.1].

NOTE: The Bottom and Top Rails each have decorative grooves on one side. This groove should face the outside [FIG 5.2].

Slide the **C-Top Guide Rail** onto the tab of the **A-Screen Cassette Assembly** [FIG 5.3].



5.1



5.2



5.3

6 POSITION SIDE RAIL WITH MAGNET

Angle the **D-Side Rail with Magnet** behind and over the **B-Bottom Guide Rail**, so that the **B-Bottom Rail** is positioned inside the flanges of the **D-Side Rail** [FIG 6.1, 6.2].

C-Top Guide Rail also positions inside the flanges of the **D-Side Rail** [FIG 6.3]. On the surface installation, the taller flange of the **D-Side Rail** is set flush to the outside of the door jamb.



6.1



6.2



6.3

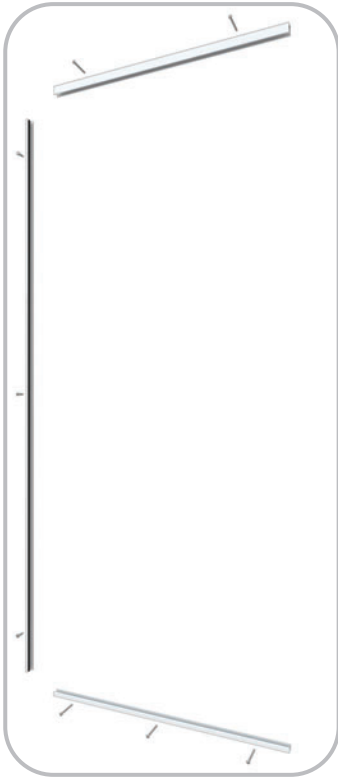

7.1

7 SECURE THE RAILS WITH SCREWS

C-Top Guide Rail: Locate the decorative trim groove [FIG 7.1] on the front surface of the C-Top Guide Rail and in this groove drill 1/8" (3mm) holes located 4" in from each end. Drill all the way through both sides of the C-Top Guide Rail. Secure the C-Top Guide Rail to the door frame using the H- #6 x 1-3/4" (44mm) Phillips Panhead Screws. Do not over tighten.

B-Bottom Guide Rail: Locate the decorative trim groove [FIG 7.1] on the front surface of the B-Bottom Guide Rail and in this groove drill 1/8" (3mm) holes located 4" in from each end and one at the center point. Drill all the way through both sides of the B-Bottom Guide Rail. Secure the B-Bottom Guide Rail to the door frame using the H- #6 x 1-3/4" (44mm) Phillips Panhead Screws. Do not over tighten. If the B-Bottom Guide Rail will be positioned where it is susceptible to being stepped upon, kicked or otherwise bent, add a structural support for the B-Bottom Guide Rail to rest upon. A 1/2" x 1/2" "L" shaped aluminum extrusion is recommended. This or another similar support material may be purchased at a local hardware store.

D-Side Rail with Magnet: Locate the small groove just inside the D-Side Rail with Magnet [FIG 7.1] and secure it to the door frame using the G-#8 x 3/4" (19mm) Phillips Panhead screws. Locate screws 6" from the top and bottom and another at the center point.



8.1

8 ADJUST THE HANDLES

Adjust the N-Handle heights by loosening the Allen-Head Set Screw, move the Handle as desired and retighten screw [FIG 8.1]. For your convenience, the K-Allen Wrench is located in the accessory kit for this step.

That's it. Enjoy your new Genius Retractable Screen!

For more great retractable screen ideas for your home, please visit

www.geniusscreens.com

TROUBLESHOOTING GUIDE

SCREEN IS DIFFICULT TO PULL OR DOES NOT GLIDE SMOOTHLY.

- ▶ Verify that the screen has been installed plumb and level. Install shims if needed.
- ▶ Check to see if the Top Pull Bar End Cap is riding too high and rubbing inside the C-Top Guide Rail. This can happen if the door sill or head has settled and is sagging or bowed. If needed, trim down only the aluminum Pull Bar to alleviate this contact point.
- ▶ Clean debris from inside the Bottom Guide Rail.

SCREEN CASSETTE ASSEMBLY DOES NOT SNAP ONTO THE RECESS MOUNT CLIPS.

- ▶ Verify that the Recess Mount Clips are installed using the dimensions specified. Take care to move back to its original shape any Recess Mount Clips that may have been bent or flattened during any previous attempts to install the Screen Cassette.

DOOR'S BOTTOM THRESHOLD SLOPES STEEPLY.

- ▶ The Bottom Guide will not work properly if installed at an angle. Use shims to adjust the Bottom Guide until level.

CLOSING MAGNETS DO NOT FULLY SEAL OR THE SCREEN DOES NOT CLOSE EVENLY.

- ▶ Clean the magnets using a mild soap and water.
- ▶ Clean any debris from inside of the Bottom Guide. When not properly maintained, debris can accumulate and interfere with the operation of the screen as well as the seal of the magnets.
- ▶ If the opening is not square or, recess (inset) the mounting clips have been bent during installation, this can cause small gaps between the magnets. To fix the issue:
 - Remove the screen and square the opening before reinstallation.
 - Remove the screen and pair any bent cassette mounting clips to restore these back to the original shape (or replace the clips if needed). Reinstall the screen.
 - Apply shims near of under the cassette mounting clips.

FOR SINGLE PANEL RECESS (INSET) MOUNTED DOOR SCREENS:

- ▶ Remove the Side Rail with Magnet and spin it around so that the deeper of the two side legs rests on the opposite side than as it was originally installed. Reinstall it using the screws. Doing this will change the alignment of the Magnets that are located in the Side Rail with Magnets and the Magnet in the Pull Bar.
- ▶ For single panel door screens which are recess (inset) mounted you can slightly change the alignment of the two magnetic strips. To alter the alignment remove the #8 x 1" (25mm) Phillips Pan head screw(s) from the center of the Dual-Mount Side Rail. Flex the center of the Dual-Mount Side Rail between 3/16" - 1/4" (4mm-5mm) toward the outside of the opening and then reinstall the screws.

It is recommended that you always retract the screen when it is not being used. This will help protect the screen fabric, magnets and other components from UV light, dirt, debris and other harmful exposure. An optional Slide Bolt Accessory Lock is also available to secure the door screen panel when needed. Please contact us for more information.

INSTALLATION QUESTIONS? MISSING PARTS? REPLACEMENT PARTS?

DON'T GO BACK TO THE STORE!

PLEASE CALL OUR HELPLINE AT

1-866-523-9511



OPERATION OF THE SCREEN

To retract the screen, disengage the Pull Bar from the magnetic latch, let go of the handle and allow the screen to retract at its own pace. The screen has a safety speed reducer feature and manually pushing the screen back into the Cassette Assembly may cause the Pull Bar to jump out of the Bottom Guide Rail or cause the screen fabric to bunch-up or leave the guides.

MAGNET CARE AND USE

To operate a magnetic latching retractable screen you must first release the magnetic seal. Do this by holding the handle and pulling toward you. This will partially separate the magnetic seal at the center point. Now simply let go of the handle and allow the screen to retract at its own pace into the protective screen cassette housing (do not push the screen faster than it is designed to retract).

SIZING DEDUCTIONS

If you are building a Genius Milano 100 screen using Bulk Packaged Components the table below provides the required cutting deductions to apply when trimming the aluminum extrusions.

Please note that all deductions should be taken away from the overall net screen opening dimensions.

Cassette Style	Cassette Deduction	Pull Bar	30mm Rail	15mm Rail	Side Rail with Magnet
42mm Milano	11/16"	2-3/16"	2-5/16"	2-5/16"	3/32"
Single Door Cassette	(17.5 mm)	(56 mm)	(58.75mm)	(58.75 mm)	(2.5 mm)

Genius Retractable Screens provide insect protection and support fresh, natural ventilation in low-wind conditions. Unlike 4-sided rigid framed screens, Genius Retractable Screens move in and out of a protective cassette and the exposed surface area and edges of the fabric are flexible. Consequently, the wind speed that a retractable screen can withstand (e.g. before the edges of the screen fabric may push out of the guide rails), will depend on the width and height of the opening, the openness factor of the specific screen fabric and, other design factors of the model. Retractable screens are not to be kept open or continually exposed to wind, sun, rain or other harsh conditions. Please be sure to use your retractable screen only during low-wind conditions.